



Owandy **RX**

Owandy
RADIOLOGY

Ow-RX: User Manual

CE 0051



6959902203

Version February 14, 2018 (Rev. 6)
<https://stomshop.pro>

Revision history Manual code 6959902203

Rev.	Date	Page	Description of the changes
0	20.02.14	-	Document approval
1	30.05.14	15, 25, 28, 29, 52, 53	Replaced CEI X-Ray tube with Toshiba D-045 model. New FW for wireless X-ray button. (Ref. RDM 7887, RDM 7904)
2	08.07.15	2, 3, from 5 to 7, 12, 14, 16, 17, from 22 to 29, from 32 to 34, 42, 61, 65	Adapted to the third edition of IEC 60601-1 and its collateral applicable rules. FCC approved revision. MET approved revision. Release of FW version 2.02 on CPU board. (Ref. RDM 7903, RDM 7988, RDM 8037)
3	19.02.16	13, 44, 45, 60	Release of FW version 2.03 on CPU board (programmed exposure pre-set times optimization, added Error 50). (Ref. RDM 8196)
4	06.09.16	17, 26, 29, 45	Added X-ray beam dimension on tube-head plate. Technical characteristics update. Added anodic current value measuring method. Added Warning on pre-set exposure times values in programmed exposure. (Ref. RDM 8363, Complaint D1639)
5	18.11.16	56	Release of FW version 1.4 for wireless X-ray button. (Ref. RDM 8416)
6	14.02.18	14, 17, 22, 33, 34, 55	Modified duty cycle value. Wireless switch conformity update (RED Directive). (Ref. RDM 8668)

THIS PAGE IS INTENTIONALLY LEFT BLANK

Contents

1. INTRODUCTION	1
1.1 Icons appearing in the manual	1
2. SPECIFICATION OF THE INTENDED USE	2
2.1 Application and medical purpose.....	2
2.1.1 Intended patient population.....	2
2.1.2 Operator profile.....	2
2.1.3 Application environments	2
2.2 Applied parts	3
2.3 Typical doses delivered to the patient during intraoral examinations	4
3. SAFETY INFORMATION	6
3.1 Warnings	7
3.1.1 Electromagnetic emissions.....	8
3.1.2 Electromagnetic immunity.....	9
3.1.3 Recommended separation distances to portable and mobile radio equipment	11
3.2 Protection against radiation.....	12
3.3 Environmental risks and displacement.....	13
3.4 Symbols used	14
4. CLEANING AND DISINFECTION	15
5. DESCRIPTION	16
5.1 Identification plates.....	16
5.2 Functions, models and versions	18
5.2.1 High Frequency (HF) Generator.....	19
5.2.2 Extension arm and scissors arm.....	19
5.2.3 Tube-head.....	20
5.2.4 Timer	20
5.3 Configurations.....	21
5.3.1 Standard configuration.....	21
5.3.2 Remote timer configuration	22
5.3.3 Mobile stand configuration	23
5.3.4 Configuration with remote X-ray button.....	24
5.3.5 Configuration with wireless X-ray button	25
6. TECHNICAL DATA	26
6.1 Method for measuring the technical factors.....	29
6.2 Tube characteristic curves.....	30

6.3	Reference standards	32
6.3.1	Reference standards related to wireless switch (applicable only to configurations with wireless X-ray button)	33
6.3.1.1	Declaration of conformity in according to the RED Directive 2014/53/EU	34
6.4	Dimensions	35
7.	GENERAL INSTRUCTIONS FOR USE	36
7.1	Control panel - Description and functions	36
7.1.1	"Tooth anatomic selection" key	38
7.1.2	"Increase/Decrease" key.....	38
7.1.3	"Select Size" key	39
7.1.4	"Function" key (selection of receptor, cone presence and kV value)	40
8.	SYSTEM USE	42
8.1	Switching ON and OFF the device.....	42
8.2	Programmed/Manual exposure	43
8.2.1	Performing a programmed exposure.....	44
8.2.2	Performing a manual exposure	46
8.3	Storing customised times	47
8.4	Preparing the tube-head	48
8.5	Exposure techniques	52
8.5.1	Bisector technique	52
8.5.2	Parallel technique	54
8.6	Exposure with the supplied X-ray button	55
8.7	Exposure with the wireless X-ray button (optional)	56
8.7.1	Indication of the battery charge status and replacement.	57
8.7.2	Matching procedure between the remote control and timer.....	57
8.8	Display of the number of exposures made	58
9.	ERROR MESSAGES ON THE DISPLAY	59
9.1	Fatal errors upon power-up and in the ready, idle and cooling statuses.....	59
9.2	Fatal errors during X-ray emission	60
9.3	NON fatal errors.....	61
10.	CONTROL AND CORRECTION OF ANY ERRORS IN THE DENTAL X-RAYS	62
10.1	Typical defects of intra-oral X-rays	62
10.2	Typical defects caused by incorrect positioning	64
11.	MAINTENANCE	65

No part of this publication may be reproduced, transmitted, transcribed or translated without the prior written consent of the manufacturer.

This manual in English is the original version.

1. INTRODUCTION

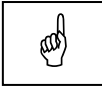

NOTE:

This manual is updated for the product it is sold with, in order to guarantee an adequate reference to use the product properly and safely. The manual may not reflect changes to the product that do not affect operating modes or safety.

The Ow-RX intra-oral X-ray unit takes high quality intra-oral X-rays thanks to reduced exposure times and the small dimensions of the focus spot.

Ow-RX is intended exclusively for intra-oral X-rays.

System operation is managed by a microprocessor, which permits high reproducibility of the exposure times.

The system consists of the following parts:

- timer: Ow-RX complete with the wall support
- extension arm (30cm, 60 cm or 80cm for the wall version)
- Scissors arm (DP)
- Tube-head (60-65-70) kV ; 6 mA

The aim of this manual is to instruct the user on the safe and effective use of the device.

The device must be used in compliance with the procedures described, and never be used for purposes different from those herewith indicated.

1.1 Icons appearing in the manual



This icon indicates a NOTE: please read the items marked by this icon thoroughly.



This icon indicates a WARNING: the items marked by this icon refer to the safety aspects of the patient and/or the operator.

2. SPECIFICATION OF THE INTENDED USE

2.1 Application and medical purpose

Ow-RX is an extraoral source X-ray unit for dental radiographic examination and diagnosis of diseases of the teeth, jaw and oral structures.

The device is to be operated and used by dentists, radiologists and other legally qualified health care professionals. It can be used with both pediatric and adult patients.

Caution:

Federal law restricts this device to sale by or on the order of a dentist, a radiologist or another legally qualified health care professional.

2.1.1 Intended patient population

Ow-RX system can be used with the following typology of patient:

- *Age:* pediatric to geriatric
- *Patient status:*
 - self-sufficient patient (patient can autonomously place himself as requested by the physician)
 - non self-sufficient patient (patient is properly helped to take the exam by medical personnel).
- *Nationality:* multiple.

2.1.2 Operator profile

This system may only be operated by persons who have the necessary expertise in radiation protection or knowledge of radiation protection and who have been instructed in the operation of the X-ray equipment.

2.1.3 Application environments

The application environments of the Ow-RX are hospitals, private clinics or consultants, other radiology facilities and also residential environment.

2.2 Applied parts

During normal use, Ow-RX comes in contact with the patient through the collimator front plastic ring, classified as Type B applied part.

2.3 Typical doses delivered to the patient during intraoral examinations

The dose ranges delivered by Ow-RX to the patient during intraoral examinations are given in the table below.

The actual value depends on the type of receptor selected (film, digital sensor, phosphor plate) and on the focus-to-skin distance (20 cm without optional collimator cone, 30 cm using optional collimator cone). The range are given for the 3 patient sizes and for the 3 high voltage values selectable.

Tooth	HV [kV]	Patient size		
		Small	Medium	Large
		Dose [mGy]	Dose [mGy]	Dose [mGy]
Incisive	60	0,29 to 0,65	0,29 to 0,78	0,46 to 1,04
Canine		0,29 to 0,65	0,29 to 0,78	0,46 to 1,04
Premolar		0,34 to 0,78	0,34 to 0,98	0,52 to 1,31
Lower molar		0,46 to 1,04	0,46 to 1,17	0,69 to 1,57
Upper molar		0,57 to 1,31	0,57 to 1,44	0,86 to 1,96
Anterior bitewing		0,29 to 0,65	0,29 to 0,78	0,46 to 1,04
Posterior bitewing		0,57 to 1,31	0,57 to 1,44	0,86 to 1,96
Incisive	65	0,25 to 0,56	0,25 to 0,67	0,39 to 0,89
Canine		0,25 to 0,56	0,25 to 0,67	0,39 to 0,89
Premolar		0,30 to 0,67	0,30 to 0,84	0,44 to 1,12
Lower molar		0,39 to 0,89	0,39 to 1,01	0,59 to 1,34
Upper molar		0,49 to 1,12	0,49 to 1,23	0,74 to 1,68
Anterior bitewing		0,25 to 0,56	0,25 to 0,67	0,39 to 0,89
Posterior bitewing		0,49 to 1,12	0,49 to 1,23	0,74 to 1,68
Incisive	70	0,21 to 0,47	0,21 to 0,56	0,33 to 0,75
Canine		0,21 to 0,47	0,21 to 0,56	0,33 to 0,75
Premolar		0,25 to 0,56	0,25 to 0,71	0,37 to 0,94
Lower molar		0,33 to 0,75	0,33 to 0,85	0,50 to 1,13
Upper molar		0,41 to 0,94	0,41 to 1,03	0,62 to 1,41
Anterior bitewing		0,21 to 0,47	0,21 to 0,56	0,33 to 0,75
Posterior bitewing		0,41 to 0,94	0,41 to 1,03	0,62 to 1,41

For the calculation of the DAP (Dose Area Product) value, refer to the above table for the dose values and apply a multiplication factor equal to:

Beam limiting device type	Area
Ø 5,8 cm standard beam limiting device	26,41 cm ²
4,5x3,5 cm rectangular beam limiting device	15,75 cm ²
2,5x3,5 cm rectangular beam limiting device	8,75 cm ²
2,0x3,0 cm rectangular beam limiting device	6,0 cm ²

3. SAFETY INFORMATION



WARNING:

Please read this chapter thoroughly.



NOTE:

The information for a proper installation and maintenance of the equipment are present in the Service Manual.

The manufacturer designs and builds the devices in compliance with the safety requirements; furthermore it supplies all information necessary for correct use, and the warnings related to danger associated with X-ray generating units.

The manufacturer cannot be held responsible for:

- use of Ow-RX equipment different from the purpose for which it was originally designed,
- damage to the unit, the operator or the patient, caused both by incorrect installation and maintenance procedures different from those described in this user and service manuals supplied with the unit, and by wrong operations,
- mechanical and/or electrical modifications performed during and after the installation, different from those described in the service manual.



WARNING:

No modification of this equipment is allowed.

Only personnel authorised by the manufacturer may carry out technical operations on the unit.

Only authorised personnel can remove the tube-head from its support and/or access the components under tension.

3.1 Warnings

The device must be used in compliance with the procedures described and never be used for purposes different from those herewith indicated.

Before performing any maintenance operation, disconnect the unit from the power supply using the provided circuit breaker.

Ow-RX is an electro-medical device and therefore it can be used only under the supervision of suitably qualified medical personnel, with the necessary knowledge on X-ray protection.

The user is responsible for the fulfilment of the legal requirements regulating the ownership, installation and use of the equipment itself.

Ow-RX has been built to support continuous operation at intermittent load; therefore please follow the described use cycles.

Wherever necessary, use the appropriate accessories, such as the leaded aprons, to protect the patient from radiation.

Ow-RX must be turned off when using electrosurgical devices or similar equipment near the unit.

This device has not been designed to be used in environments where anaesthetic mixtures flammable with air, oxygen or nitrous oxide can be detected.

In order to prevent risks of short-circuit and corrosion, avoid the entry of water or other liquids in the equipment.

The parts of the unit that can come into contact with the patient must be cleaned regularly according to the instructions provided below in this document.



WARNING:

For safety reasons, it is prohibited to abnormally overload the extension arm or the scissors arm, for example by leaning on it.



WARNING:

To avoid risk of electric shock, this equipment must only be connected to a supply mains with protective earth.

3.1.1 Electromagnetic emissions

In accordance with the IEC 60601-1-2 standard, Ow-RX is suitable for use in the electromagnetic environment specified below.
The customer or user of the system must ensure that it is used in the said environment.

Emissions test	Conformity	EMC environment of use
RF emissions CISPR 11	Class B	Ow-RX is suitable for use in all domestic environments and in environments directly connected to the mains power supply at low voltage that supplies buildings for domestic use.
	Group I	Ow-RX uses RF power only for its internal functioning. As a result, its RF emissions are very low and most likely will not cause any interference in electronic devices located nearby.
Harmonic emissions IEC 61000-3-2	Class A	
Flicker/voltage fluctuation emissions IEC 61000-3-3	In compliance	

3.1.2 Electromagnetic immunity

In accordance with the IEC 60601-1-2 standard, Ow-RX is suitable for use in the electromagnetic environment described below. The customer or user of the system must ensure that it is used in the said environment.

Immunity test	Test level IEC 60601-1-2	Compliance level	EMC environment of use
Electrostatic discharges (ESD) IEC 61000-4-2	± 6 kV contact ± 8 kV in air	± 6 kV contact ± 8 kV in air	The flooring must be wood, concrete or ceramic tile. If the flooring is covered with synthetic material, the relative humidity must be at least 30%.
Transients/sequence of rapid electric impulses IEC 61000-4-4	± 2 kV for power supply lines ± 1 kV for input/output lines	± 2 kV for power supply lines ± 1 kV for input/output lines	The quality of the mains voltage must be the same as a typical commercial or hospital environment.
Overvoltages IEC 61000-4-5	± 1 kV between phases ± 2 kV between phase and earth	± 1 kV between phases ± 2 kV between phase and earth	The quality of the mains voltage must be the same as a typical commercial or hospital environment.
Voltage dips, short breaks and voltage variations of the power supply feed line IEC 61000-4-11	0 % U_t for 0.5 cycles 40 % U_t for 5 cycles 70 % U_t for 25 cycles 0 % U_t for 5 s	0 % U_t for 0.5 cycles 40 % U_t for 5 cycles 70 % U_t for 25 cycles 0 % U_t for 5 s	The quality of the mains voltage must be the same as a typical commercial or hospital environment. If the Ow-RX user requires continuous operation during interruptions in the mains voltage, it is recommended to power the Ow-RX with an uninterrupted power supply or batteries.
Magnetic field at the main frequency (50/60 Hz) IEC 61000-4-8	3 A/m	3 A/m	The levels of the magnetic fields at mains frequency must be the same as a typical commercial or hospital environment.
Note: U_t is the a.c. mains voltage prior to the application of the test level.			

Immunity test	Test level IEC 60601-1-2	Compliance level	EMC environment of use
			<p>The RF portable and mobile communications units should not be used closer to any part of the Ow-RX, including cables, than the recommended separation distance calculated from the equation applicable to the frequency of the transmitter.</p> <p>Recommended separation distance:</p>
Radiated RF IEC 61000-4-3	3 V/m from 80 MHz to 2.5 GHz	3 V/m	<p>$d = 1.2 \times \sqrt{P}$ from 80 MHz to 800 MHz</p> <p>$d = 2.3 \times \sqrt{P}$ from 800 MHz to 2.5 GHz</p>
Conducted RF IEC 61000-4-6	3 V from 150 kHz to 80 MHz	3 V	<p>$d = 1.2 \times \sqrt{P}$</p>
			<p>where "P" is the maximum rated output of the transmitter in watts (W) according to the transmitter manufacturer and "d" is the recommended separation distance in meters (m).</p> <p>The field strength of the fixed RF transmitters, determined by an on-site electromagnetic survey, should be lower than the compliance level in each frequency range.</p> <p>Interference may be verified near devices marked with the following symbol:</p> 

3.1.3 Recommended separation distances to portable and mobile radio equipment

Ow-RX is designed to operate in an electromagnetic environment in which radiated RF disturbances are controlled. The customer or user of the system can help prevent electromagnetic interference by ensuring a minimum distance between mobile and portable RF communication devices (transmitters) and Ow-RX as recommended in the following table in relation to the maximum output power of the radio devices.

Maximum rated output power of the transmitter (W)	Separation distance according to the frequency of the transmitter (m)		
	from 150kHz to 80MHz $d = 1.2 \times \sqrt{P}$	from 80MHz to 800MHz $d = 1.2 \times \sqrt{P}$	from 800MHz to 2.5GHz $d = 2.3 \times \sqrt{P}$
0.01	0.12	0.12	0.23
0.1	0.38	0.38	0.73
1	1.2	1.2	2.3
10	3.8	3.8	7.3
100	12	12	23

For transmitters maximum rated output not shown in the table, the recommended separation distance "d" in meters (m), can be calculated using the equation applicable to the frequency of the transmitter, where "P" is the highest rated output of the transmitter in watts (W) according to the manufacturer of the transmitter.

Note 1: at 80 MHz and 800 MHz, apply the separation distance for the higher frequency interval.

Note 2: these guidelines may not apply to all situations. Electromagnetic propagation depends on the absorption and reflection of structures, objects and people.

3.2 Protection against radiation

Although the dose supplied by modern X-ray units is quite low, the operator must adopt the precautions and/or suitable protection for the patient and himself according to current regulations, during the execution of radiography.

**WARNING:**

Protection against radiation is regulated according to law. The equipment may only be used by specialised personnel.

- a) The film (or the digital sensor) must be placed in the patient's mouth either manually or using the specific supports, and must be held in position by the patient if necessary.
- b) During exposure to the rays, the operator must not be in contact with the tube-head or the collimator cone.
- c) During exposure, the operator must maintain a certain distance from the source of the rays (at least 2 metres) in the opposite direction of the emission.
- d) During exposure, only the operator and the patient may be present in the room.
- e) Use the specific leaded aprons to reduce the undesired effect of secondary radiations for the patient.

**NOTE:**

In reference to the image receptor used, the operator must consider the presence of residual radiation.

3.3 Environmental risks and displacement

Some of the device's components contain material and liquids that, at the end of the equipment life-cycle, must be disposed of at the recycling centres appointed by the local health units.

In particular, the device contains the following materials and/or components:

- **Tube-head:** non biodegradable plastic materials, glass, dielectric oil, lead, tungsten, aluminium, copper.
- **Other parts of the device:** non biodegradable plastic materials, metal materials, printed circuits, iron-plastic materials.



INFORMATION FOR USERS OF THE EUROPEAN UNION according to 2012/19/EU Directive on waste electrical and electronic equipment (WEEE)



The symbol with the waste bin crossed on the equipment or its packaging, indicates that the product must be separately collected from other waste at the end of its life.



















The separate collection of the present equipment that has reached the end of its life is organised and managed by the manufacturer. The user who wishes to dispose of this equipment must contact the manufacturer and follow their system to enable the separate collection of the equipment at the end of its life.

Suitable separate waste collection for the subsequent start of the equipment discarded for recycling, for treatment and for environmentally friendly disposal, contributes in preventing possible adverse effects on the environment and health and promotes the reuse and/or recycling of materials of which the equipment is comprised.

Illegal disposal of the product by the holder implies the application of administrative sanctions provided by law

3.4 Symbols used

In this manual and on the Ow-RX itself, apart from the symbols indicated on the keypad, also the following icons are used (see Chapter 7):

Symbol	Description
	Device with type B applied parts
	In some of its parts, the device contains materials and liquids that, at the end of the lifespan of the unit, must be disposed of at the appropriate disposal centres
~	Alternating Current
N	Connection point to the neutral conductor
L	Connection point to the line conductor
	Earth protection
	Operation earthing
	OFF; device not connected to the mains
	ON; device connected to the mains
	Exposure enabling key; the exposure enabled status is indicated by the switching on of the corresponding green symbol
	Ray Emission
	Focus spot according to IEC 336
	Warning: see the accompanying documentation
	Product identification code
	Serial number
	Date of manufacture (year and month)
	Manufacturer's name and address
	Filtration
	Tube-head
	X-ray tube
	Conformity to the EC 93/42 Directive and subsequent amendments and additions (subsequent amendments and additions)
	Guarantees wireless switch for Ow-RX compliance with RED Directive 2014/53/EU

4. CLEANING AND DISINFECTION

In order to guarantee a good level of hygiene and cleaning, it is necessary to respect the following procedures:

- **Before starting any cleaning operation, disconnect the unit from the mains using the main line switch that must be foreseen during the installation phase. This manoeuvre is necessary because some parts inside the unit are still live even after it was turned off using the power switch.**
- Make sure water or other liquids do not penetrate inside the unit in order to prevent short circuits or corrosion.
- Never use corrosive or abrasive substances (alcohol, petrol, trichloroethylene) to clean the unit.

External surfaces

Use a soft cloth and for more effective cleaning, use neutral soap and be careful not to damage the painted surfaces.

During cleaning operations, make sure that the detergent and/or liquids do not enter inside the unit or remain on the painted surfaces.

Parts in contact with the patient's skin

To ensure the hygiene of these parts, they should be periodically disinfected with a 2% glutaraldehyde solution.

5. DESCRIPTION

5.1 Identification plates

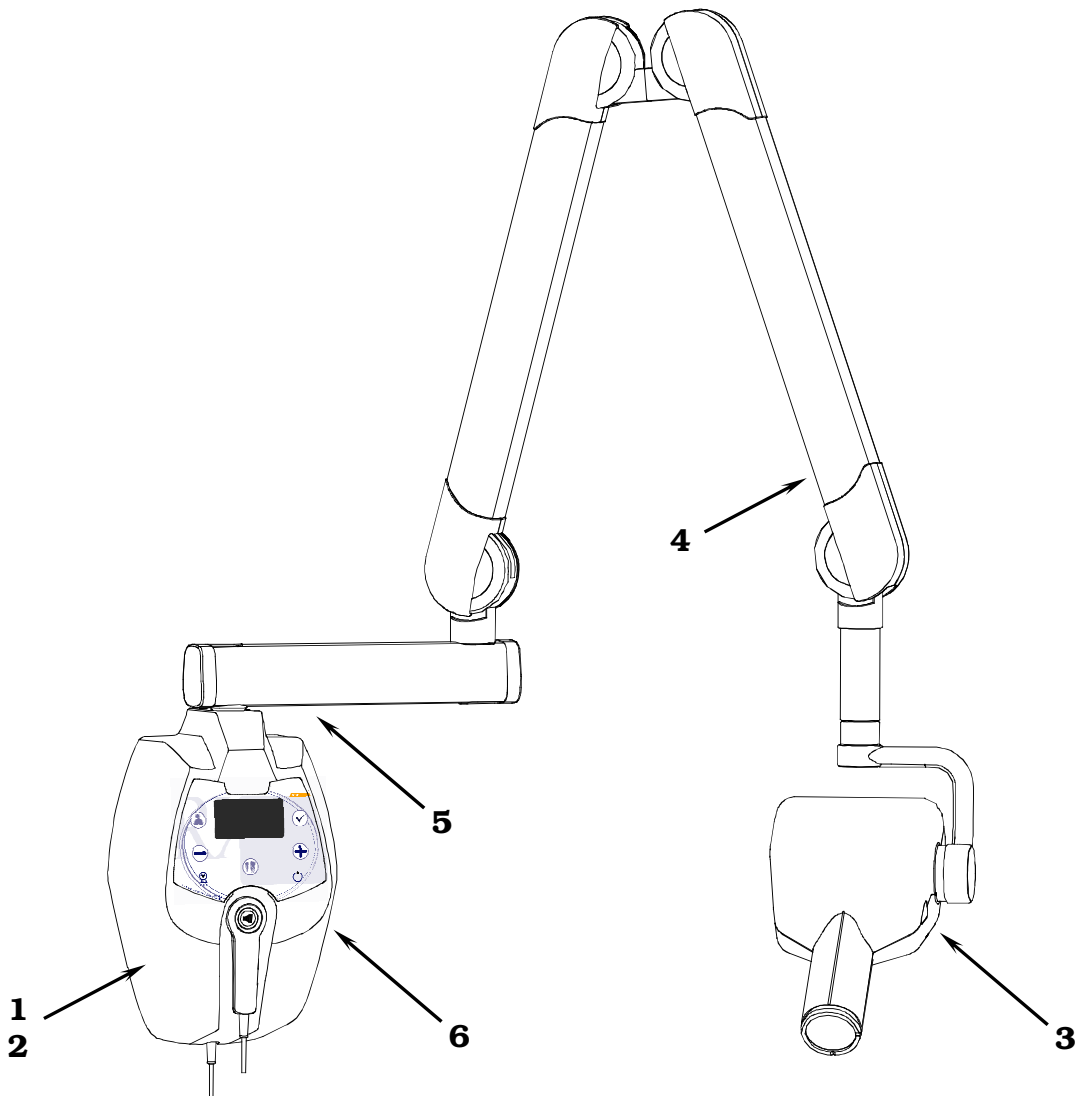

1a
Ow-RX plate

Owandy
RADIOLOGY **Ow-RX**
Line: 110-240V~;2.4A (240V~); 5.4A (110V~); 50/60Hz
Duty cycle: 1/30 Max exposure time: 2 s

REF 835931XXXX
SN 29YYXXXX YYY-MM

OWANDY RADIOLOGY
2 rue des Vieilles Vignes
77183 Croissy Beaubourg
FRANCE

CE 0051 This product complies with FDA radiation performance standards 21 cfr subchapter J, in effect at date of manufacture

1b
Ow-RX plate for configuration with
Wireless X-ray button

Owandy **Ow-RX**
RADIOLOGY Line: 110-240V~;2.4A (240V~);
5.4A (110V~); 50/60Hz
Duty cycle: 1/30 Max exposure time: 2 s

REF 835931XXXX **SN** 29YYXXXX YYY-MM

OWANDY RADIOLOGY
2 rue des Vieilles Vignes
77183 Croissy Beaubourg
FRANCE

CE 0051 This product complies with FDA radiation performance standards 21 cfr subchapter J, in effect at date of manufacture

This device complies with part 15 of the FCC Rules. Operation is subject to the following two conditions: (1) This device may not cause harmful interference, and (2) this device must accept any interference received, including interference that may cause undesired operation

Contains FCC ID: 2ABYS76593030

2
MET certification plate

MET **us** Complies with
AAMI ES 60601-1
CSA C22.2 No. 60601-1
E114042

3
Tube-head plate

Owandy **REF** 845940040
RADIOLOGY **SN** 39YYZZZ YYY-MM

Output max: 70 kVp 6 mA 2 s
X-ray beam: $\varnothing \geq 6$ cm at SID 20 cm
0.4 IEC60336 ≥ 2.5 mm Al

REF D-045 **SN** XXXXXX Toshiba Japan

OWANDY RADIOLOGY
2 rue des Vieilles Vignes
77183 Croissy Beaubourg
FRANCE

This product complies with FDA radiation performance standards 21 cfr subchapter J, in effect at date of manufacture

4
DP arm
plate

REF 815920000
SN 18YYZZZ

5
Extension arm
plate

REF 8161200X02
SN 10YYZZZ

6
WARNING
plate

COMPLIES WITH DHHS PERFORMANCE STANDARD 21 CFR SUBCHAPTER J

WARNING:
THIS X RAY UNIT MAY BE DANGEROUS TO THE PATIENT AND OPERATOR UNLESS SAFE EXPOSURE FACTORS AND OPERATING INSTRUCTIONS ARE OBSERVED.
ELECTRICAL SHOCK AZARD - DO NOT REMOVE PANELS. RISK OF EXPLOSION. DO NOT USE IN PRESENCE OF FLAMMABLE ANESTHETICS. FOR CONTINUED PORTECTION AGAINST RISK OF FIRE, REPLACE ONLY WITH SAME TYPE AND RATING OF FUSE.

DANGER:
CET APPAREIL DE RADIODIAGNOSTIC PEUT ETRE DANGEREUX POUR LE PATIENT ET L'OPERATEUR SI LES FACTEURS D'EXPOSITION ET LES INSTRUCTIONS NE SONT PAS SUIVIS. RISQUE D'EXPLOSION
- NE PAS EMPLOYER EN PRESENCE D'ANESTHESIQUES INFLAMMABLES. POUR ASSURER UNE PROTECTION CONTINUE CONTRE LE RISQUE D'INCENDIE, UTILISER UNIQUEMENT UN FUSIBLE DE RECHARGE DE MEME TYPE ET DE MEMES CARACTERISTIQUES NOMINALES.

7
Collimator 30 cm (optional)
plate

OWANDY RADIOLOGY
2 rue des Vieilles Vignes
77183 Croissy Beaubourg
FRANCE

BEAM LIMITING DEVICE
REF 61594000
 $\varnothing \leq 6$ cm at FFD 30cm
SN 42YYZZZ YYY-MM

This product complies with FDA radiation performance standard 21 CFR subchapter J, in effect at date of manufacture

8
Wireless X-ray button (optional)
plate

Wireless switch for Ow-RX
REF 7659303200
Owandy **SN** 30YYXXXX
RADIOLOGY
2 rue des Vieilles Vignes
77183 Croissy Beaubourg
FRANCE

CE

This device complies with part 15 of the FCC Rules. Operation is subject to the following two conditions: (1) This device may not cause harmful interference, and (2) this device must accept any interference received, including interference that may cause undesired operation

Contains FCC ID: 2ABYS76593030

5.2 Functions, models and versions

The Ow-RX intra-oral X-ray unit makes it possible to obtain consistently high quality X-rays thanks to the reproducibility of the unit parameters with very short exposure times and a very small focus spot.

The Ow-RX intra-oral X-ray unit is compatible for being combined with digital image acquisition systems, thereby obtaining the maximum benefits of today's digital intra-oral radiologic technology. If you do not currently have a digital system, the use of high-speed film or film in the EKTRASPEED (Kodak) category is recommended in order to limit the dose absorbed by the patient. A button on the control keypad is used to select the operating mode and it is possible to select films with different speeds (sensitivity), the phosphor sensor, the digital sensor or a customised user mode "Custom mode".

The Ow-RX X-ray unit has an LCD display with dimensions of 84mm x 45mm (240x128 pixel) which makes it easier for the operator to perform all operations, guaranteeing the immediate and complete display of the exposure parameters.

The Ow-RX system can use the optional 30 cm collimator cone (to be ordered separately). The "long cone inserted" selection is signalled by the specific symbol on the display. In this configuration, the exposure times that were pre-set in the anatomic selection are automatically increased by a multiplicative factor of 2.

The Ow-RX system includes the following: generator, tube-head complete with collimator, CPU (or logic) card that controls the system functions, keypad, extension arm and scissors arm.



WARNING:

The Ow-RX system does not automatically detect the presence of a cone or other item: the operator is responsible for checking the congruity between the indication on the display and the actual situation of use.

5.2.1 High Frequency (HF) Generator

The remote controlled HF generator, together with the tube-head, uses state-of-the-art microelectronic technology to obtain optimal quality X-rays while reducing the patient dose of rays. Conventional systems generally use the intrinsic capacity of the RX generator tube to conduct the electric current in one direction only. This generates a "train" of RX impulses. The Ow-RX unit instead uses constant-voltage technology that generates continuous and stable emission of X-rays. This reduces the emission of soft rays, guaranteeing the constancy of the emission parameters, kVp and mA.

The microprocessor-based control ensures constant and repeatable exposure times; by simply pressing a button it is possible to automatically select the exposure times based on the size of the patient and the selected tooth.

5.2.2 Extension arm and scissors arm

This consists of an arm with a double joint, which permits horizontal and upward extension. The tube-head remains balanced in all positions.



NOTE:

The scissors arm was designed to work correctly with a maximum opening angle of 160°; therefore, an opening angle of less than 160° is required for its use.

A horizontal extension arm can also be added, which is available in different sizes (30 / 60 / 80 cm) to satisfy all requirements.

5.2.3 Tube-head

The tube-head makes it possible to select one of three different high voltage values: 60 / 65 / 70 kVp.

The radiogenic unit is equipped with a collimator with a focus skin distance of 20 cm and a ray emission diameter of 6 cm at the cone exit. The tube-head is connected to the arm by a guide, which permits 390° horizontal rotation and 290° vertical rotation.

5.2.4 Timer

The timer consists of an LCD display (240x128 pixel), two LEDs (yellow: X-rays in progress– green: ready for X-rays) and 5 buttons that are used to select from among 3 different patient sizes, 3 types of sensors (film, phosphor or digital) and 7 different pre-set anatomical structures (incisor, canine, premolar, lower molar, upper molar, front bite-wing and rear bite-wing).

There are 36 fixed times available for manual selection which vary from a minimum of 0.01 seconds up to a maximum of 2 seconds.

The timing is managed in order to guarantee exact precision of the exposure times.



NOTE:

The configuration can be set using the remote X-ray control outside the examination room. This consists of a wall support onto which the X-ray button is connected with an extendable cable.



NOTE:

The unit provides two separate contacts for the possible connection with external signalling devices. One contact signals the status of the unit as operative and ready to be used, the second emits the X-rays. The connection methods and the requirements necessary for the signalling devices are described in the "Service Manual".

5.3 Configurations

5.3.1 Standard configuration

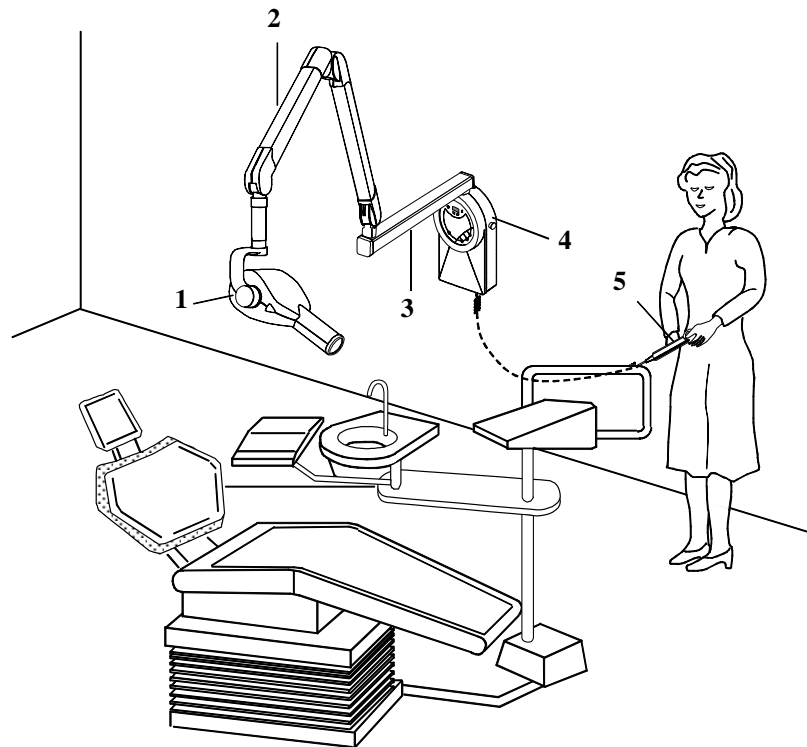

Figure 1

- 1** Tube-head
- 2** Scissors arm
- 3** Extension arm
- 4** Timer
- 5** X-ray button

5.3.2 Remote timer configuration

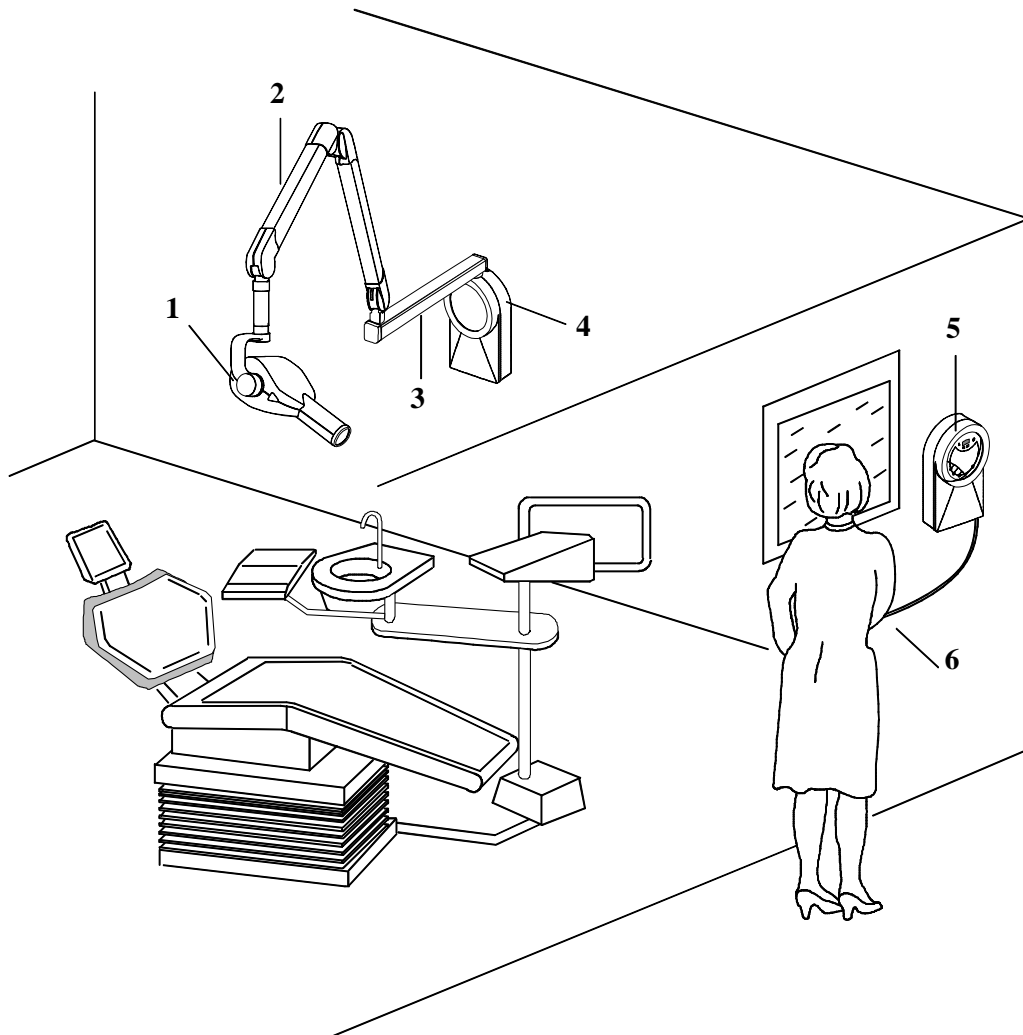
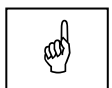

Figure 2

- 1 Tube-head
- 2 Scissors arm
- 3 Extension arm
- 4 Wall support
- 5 Remote timer
- 6 X-ray button



NOTE:

Verify that, in the radiological room, direct audio and visual communication between operator and patient is always possible. Otherwise, provide proper support (i.e. lead glass or similar, interphone, etc.).

5.3.3 Mobile stand configuration

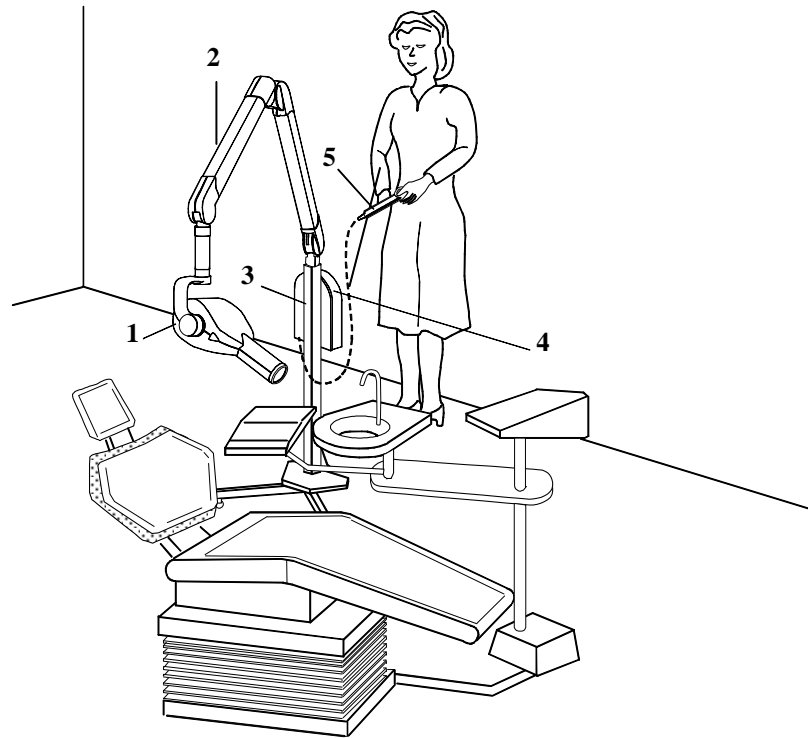

Figure 3

- 1 Tube-head
- 2 Scissors arm
- 3 Stand
- 4 Timer
- 5 X-ray button



WARNING:

The mobile version must be positioned so that the plug disconnection is not difficult.

5.3.4 Configuration with remote X-ray button

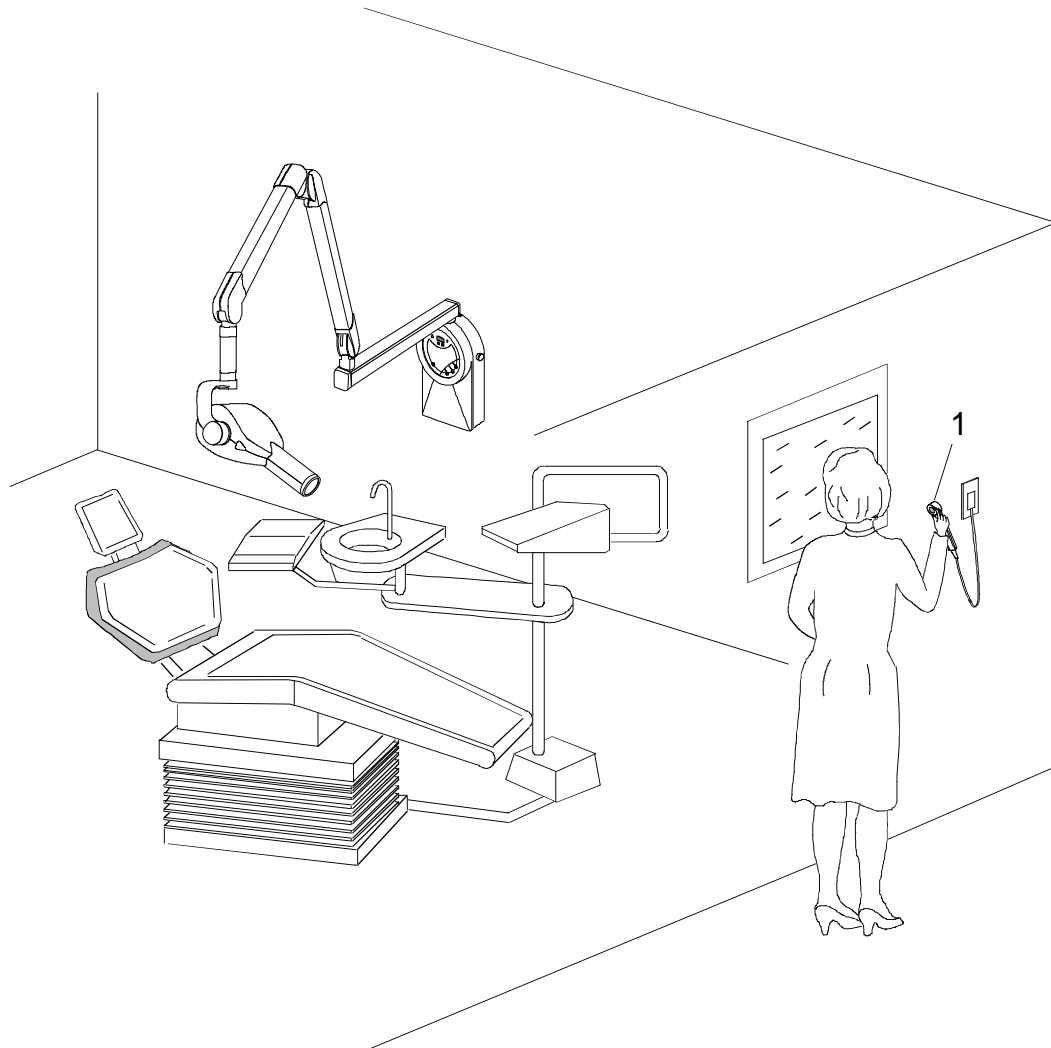

Figure 4

1 Remote X-ray button (optional)



NOTE:

Verify that, in the radiological room, direct audio and visual communication between operator and patient is always possible. Otherwise, provide proper support (i.e. lead glass or similar, interphone, etc.).

5.3.5 Configuration with wireless X-ray button

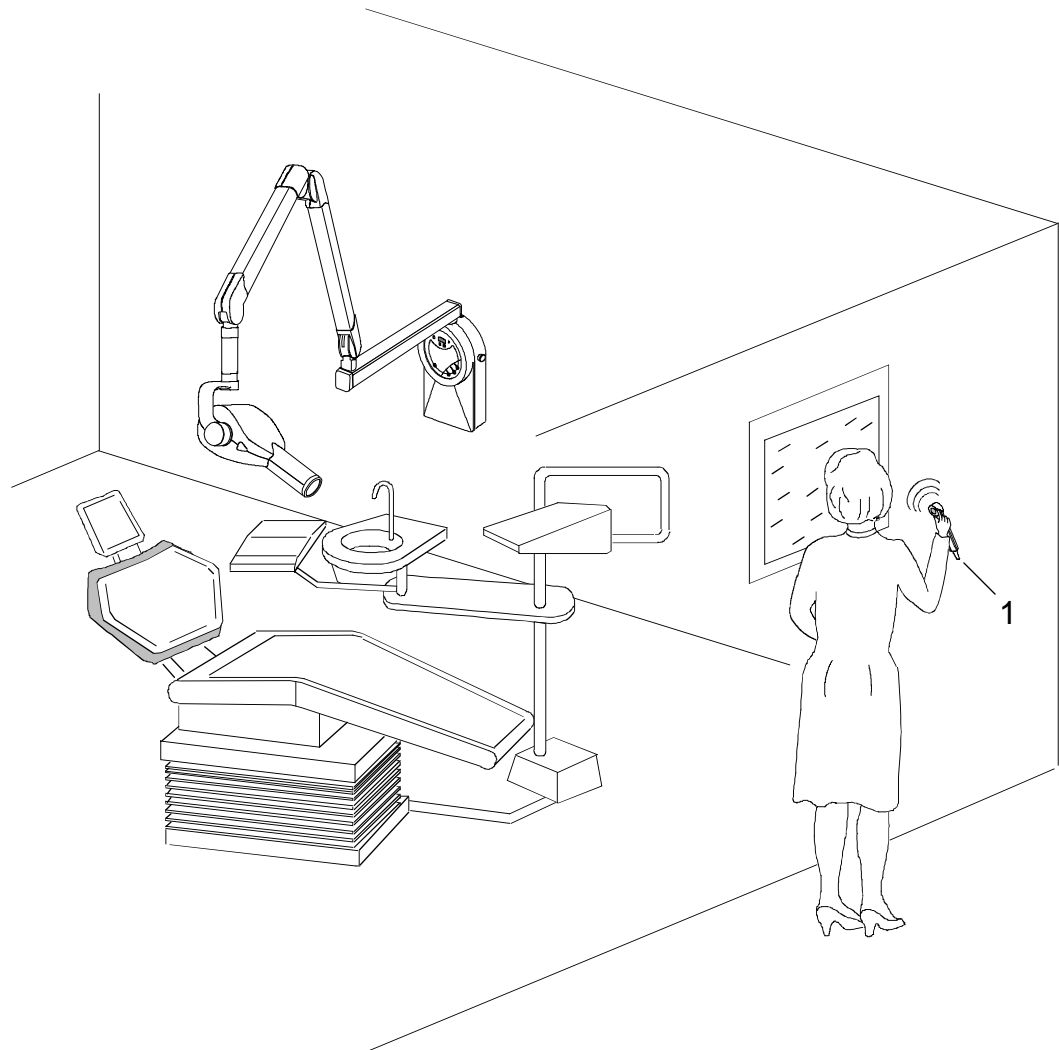

Figure 5

1 Wireless X-ray button (optional)



NOTE:

Verify that, in the radiological room, direct audio and visual communication between operator and patient is always possible. Otherwise, provide proper support (i.e. lead glass or similar, interphone, etc.).

6. TECHNICAL DATA

Technical characteristics	
Equipment	Ow-RX
Manufacturer	OWANDY RADIOLOGY 77183 Croissy-Beaubourg - France
Class	Class I with type B applied parts (according to EN 60601-1 classification) 
Protection degree	IPX0 standard device
Line voltage	99-264 V~
Rated voltage	110-240 V~
Line frequency	50 / 60 Hz
Line current	5.4 A rms impulsive @ 110 V ~ 2.4 A rms impulsive @ 240 V ~
Maximum line current	7 A rms impulsive @ 99 V ~
Technical factors for maximum line current	70kV, 6mA
Absorbed power	582 VA @ 110 V ~ 570 VA @ 240 V ~
Maximum apparent line resistance	0.4 Ω (99-180 V ~) 0.8 Ω (181-264 V ~)
Line voltage regulation	$\leq 3\%$
Mains fuse (F1)	T 6.3 A - 250 V
Mains fuse (F3 - only for mobile version)	T 6.3 A - 250 V
Selectable times	from 0.01 to 2.00 s in 36 steps
Automatic selection	882 pre-programmed times (7 anatomic - 3 sizes - 3kV - 2 SID- 3 receptors)
Time accuracy	$\pm 5\% \pm 2$ ms
High voltage values	60-65-70 kVp selectable
Tubehead current	6 mA
kV accuracy	$\pm 8\%$ @ rated voltage
Tubehead anodic current accuracy	$\pm 10\%$ @ rated voltage
Maximum exposure time	2.0 s
Timer size	284×253×123.3 mm

Tube-head characteristics	
Manufacturer	Owandy Radiology
Rated voltage	60-65-70 kV _p (selectable)
Tubehead power	420 W
Total filtration	≥ 2.5 mm Al eq. @ 70 kV
HVL (Half value Layers)	> 2 mm Al eq.
Transformer insulation	Oil bath
Interval between the exposures / duty cycle	30 times the X-ray time / 1 : 30
Minimum focus to skin distance	20 cm (optional 30 cm cone)
Focus position	See Figure 6
Target angle	See Figure 7
X-ray diameter (@ 20cm focus)	≤ 6 cm (35x45 mm + 25x35 mm + 20x30 mm optional)
Cooling	Convection
Leakage radiation at 1 metre	< 0.25 mGy/h
Technical factors for leakage radiation	70 kV, 6 mA, 1 s duty cycle 1 exposure every 30 seconds
Max specified energy input in 1 hour	720mAs @ 70kV, 2s

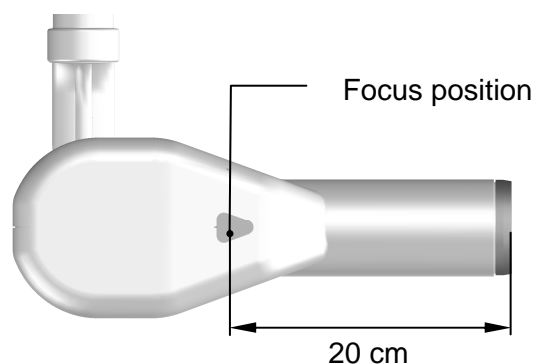

Figure 6: Tubehead focus position

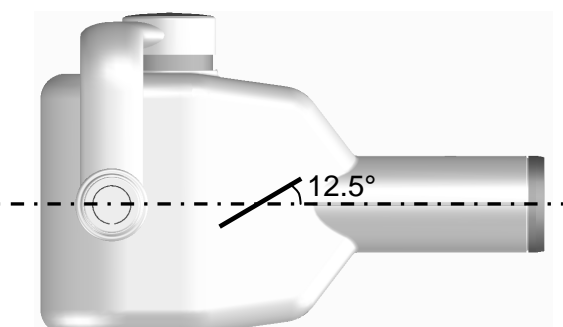

Figure 7: Tubehead target angle

X-ray tube characteristics	
Manufacturer	Toshiba Japan
Type	D-045
Inherent filtration	at least 1 mm Al
Focus size	0.4 (IEC 60336)
Anode tilt angle	12.5°
Anode material	Tungsten
Nominal max voltage	70 kV
Filament max voltage	3.1 V
Filament max current	3 A
Anode thermal capacity	4.3 kJ
Anode cooling capacity (max)	100 W
Environmental conditions	
Operating temperature range	+10°C ÷ +40°C
Relative working humidity (RH) range	30% ÷ 75%
Operating atmospheric pressure range	700 ÷ 1060 hPa
Temperature range for transport and storing	-20°C ÷ +70°C
Humidity range for transport and storing	<95 % non-condensing
Minimum atmospheric pressure for storing and transport	630hPa
Weight of the unit and the removable parts	
Gross weight including packaging	30 kg
Net weight of the unit in the standard configuration	23 kg
Extension arm 60 cm (standard)	2.9 kg
Extension arm 80 cm	3.5 kg
Extension arm 30 cm	1.9 kg
Scissors arm with tube-head support	10 kg
Timer + wall support	5.05 kg
Net weight of the mobile stand	31 kg
Timer + mobile stand support	4.7 kg
Tube-head	5 kg

6.1 Method for measuring the technical factors

The measuring method with non-invasive instruments, for example kV_p/t meter, is accepted, even if it generally provides less accuracy. In fact, the measurement of the high voltage at the tube with non-invasive instruments is closely correlated to the method selected by the instrument manufacturer; in general, this method is more inaccurate than the direct method and may also require two subsequent exposures. In the same way, the method of measuring the anodic current with the indirect method is affected by systematic errors, as they are often based on the measurement of the current/time product, dividing the measurement by the time measured with the said method.

- **High voltage value at the tube (kVp)**

The kVp value is defined as the stationary value of the high voltage applied at the tube that is stabilised under load after the pre-heating time.

Measure the value of the kVp with a non-invasive instrument (with 2% accuracy), setting the exposure time to 1 second.

- **Anodic current value**

The anodic current value is defined as the average value of stationary current which settles on load after pre-heating time.

The anodic current value is measured using a digital voltmeter measuring the voltage drop at the ends of the resistor assembled on the tubehead. To take this measurement, remove the tubehead covers; connect the ground voltmeter terminal on the yellow/green cable side of the resistor and connect the positive terminal at the other side of the resistor. The digital voltmeter must be selected on DC, and the relation of transformation is given by 1 mA = 1V. Execute an exposure setting the exposure time to 1 second.

- **Measuring the exposure time**

The exposure time must be measured using a non-invasive instrument.

In compliance with standard IEC 60601-2-7, the exposure time is measured as the interval of time between the moment in which the air Kerma has reached the 50% of the peak value and the moment in which it goes down below this value.



NOTE:

It is recommended to perform annually the technical factors measure according to the local rules, checking that the technical factors accuracy is within the limits given in the technical characteristics.

6.2 Tube characteristic curves

D-045

Emission & Filament characteristics

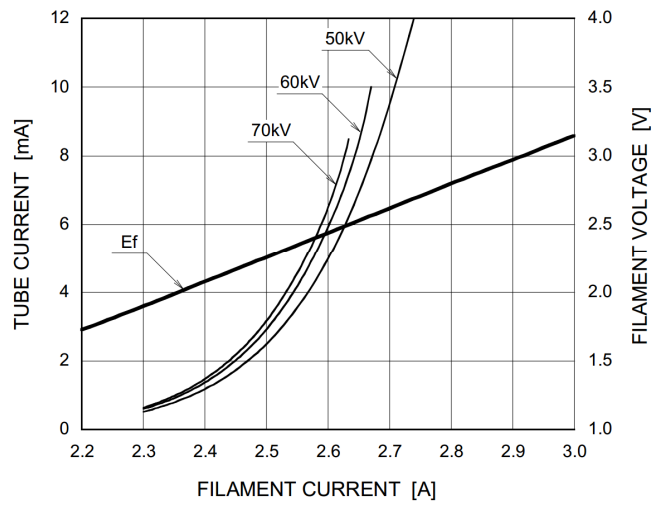

Load

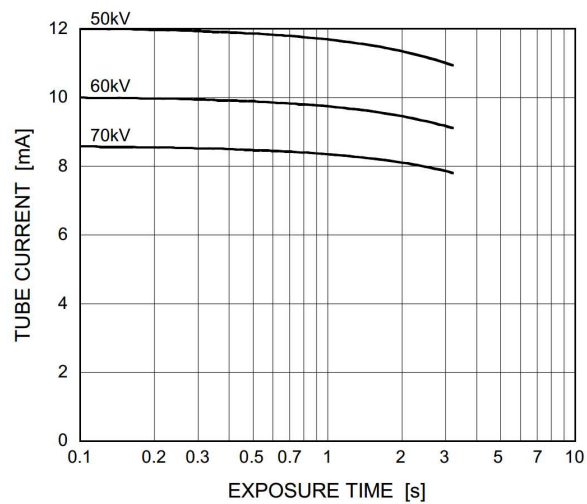

Anode cooling curve

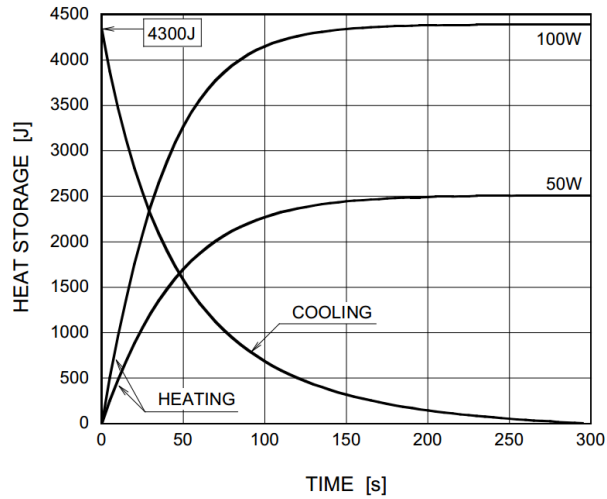

Tube-head cooling curve

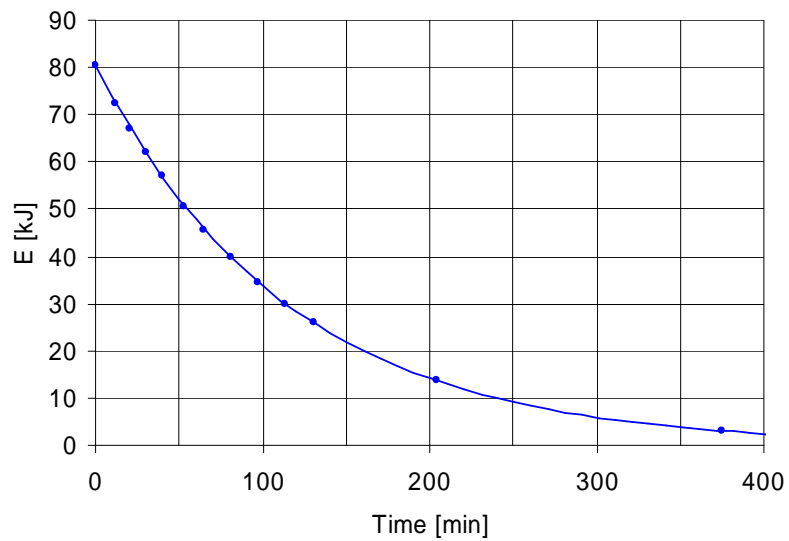

6.3 Reference standards

Ow-RX complies with the following standards:

IEC 60601 1: 2005 + Corr.1 (2006) + Corr.2 (2007)

Medical electrical equipment - Part 1: General requirements for basic safety and essential performance

IEC 60601-1-6:2010 (3rd Ed.)

Medical electrical equipment - Part 1-6: General requirements for safety - Collateral Standard: Usability including IEC 62366: Application of usability engineering to medical devices.

IEC 60601-1-2:2007 (3rd Ed.)

Electromagnetic compatibility – Requirements and test.

IEC 60601-1-3:2008 (2nd Ed.)

Medical electrical equipment - Part 1-3: General Requirements for Radiation Protection in Diagnostic X-Ray Equipment.

IEC 60601-2-65:2012

Particular requirements for the basic safety and essential performance of dental intra-oral X-ray equipment.

IEC 62304:2006 + Ac:2008

Medical device software - Software life-cycle processes.

IEC 62366:2007 (1st Ed.)

Medical devices – Application of usability engineering to medical devices.

EN-ISO 14971:2012

Medical Devices - Application of Risk Management to Medical Devices.

CAN/CSA-C22.2 No 60601-1:08

Medical Electrical Equipment - Part 1: General Requirements for Basic Safety and Essential Performance.

ANSI/AAMI ES60601-1:2005

Medical electrical equipment, Part 1: General requirements for basic safety and essential performance

 0051 Guarantees Ow-RX compliance with Directive 93/42 and as amended (subsequent amendments and additions)

CFR 21

Code Federal Regulation. Sub Chapter J

Canadian Medical Device Regulations

6.3.1 Reference standards related to wireless switch (applicable only to configurations with wireless X-ray button)

Ow-RX contains radio module with FCC ID: 2ABYS76593030

The wireless switch for Ow-RX complies with the following standards:

ETSI EN 300 220-2 v.3.1.1

ETSI EN 301 489-3 v.1.6.1 and Final Draft ETSI EN 301 489-3 v.2.1.1

Electromagnetic Compatibility and Radio Spectrum matters (ERM).



Guarantees wireless switch for Ow-RX compliance with RED Directive 2014/53/EU

CFR title 47 part 15

Subpart C-Intentional Radiators 15.231

Changes or modifications not expressly approved by the manufacturer could void the user's authority to operate the equipment.

This device complies with part 15 of the FCC Rules. Operation is subject to the following two conditions: (1) This device may not cause harmful interference, and (2) this device must accept any interference received, including interference that may cause undesired operation.

6.3.1.1 Declaration of conformity in according to the RED Directive 2014/53/EU

OWANDY Radiology

Declare under our sole responsibility that the product:

Product name: **Wireless switch for Ow-RX**

Trade name: **OWANDY Radiology**

Type: **7659303200**

to which this declaration relates is in conformity with essential requirements and other relevant requirements of the RED Directive 2014/53/EU.

Art. 3(1)(a) - Health

Art. 3(1)(a) - Safety

Art. 3(1)(b) - EMC EN 301 489-3 v1.6.1 and Final Draft EN 301 489-3 v2.1.1, EN 301 489-1 v1.9.2

Art. 3(2) - RADIO SPECTRUM ETSI EN 300 220-2 v3.1.1 (2017)

Technical file held by:

OWANDY Radiology

2, rue des Vieilles Vignes

77183 Croissy-Beaubourg - FRANCE

Croissy-Beaubourg, 21/11/17

Eric FAUVARQUE,

Directeur Général,

General Manager,

Director General,



6.4 Dimensions

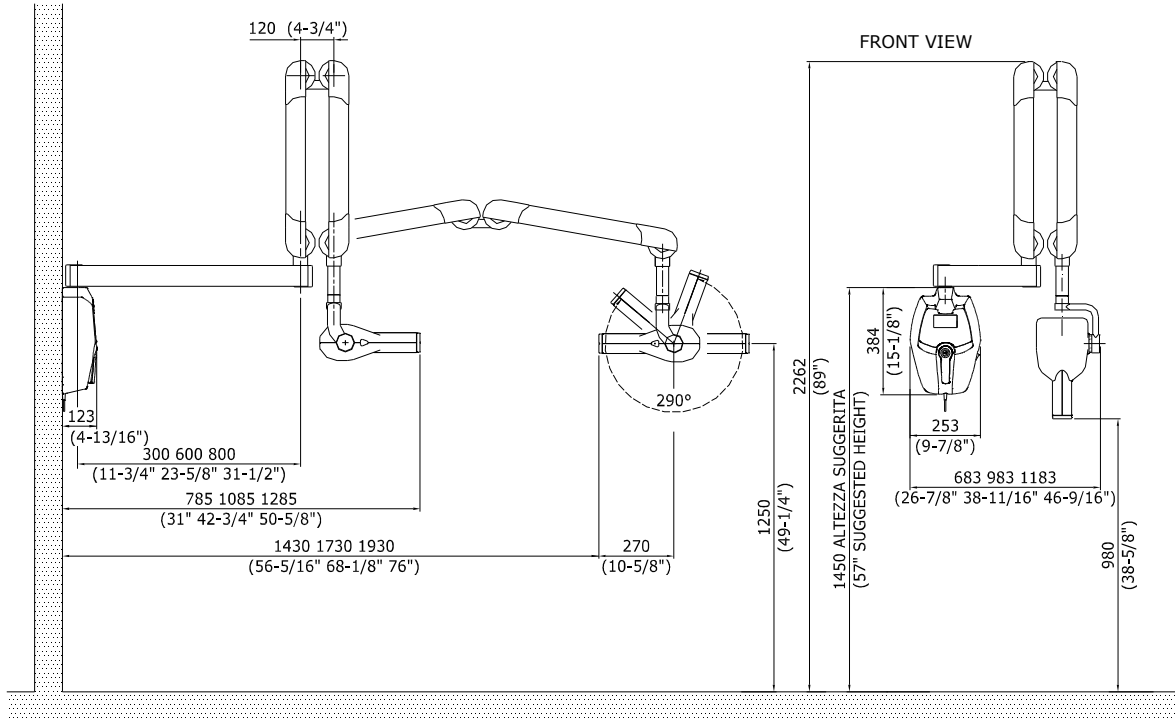

Figure 8: Dimensions of the wall version

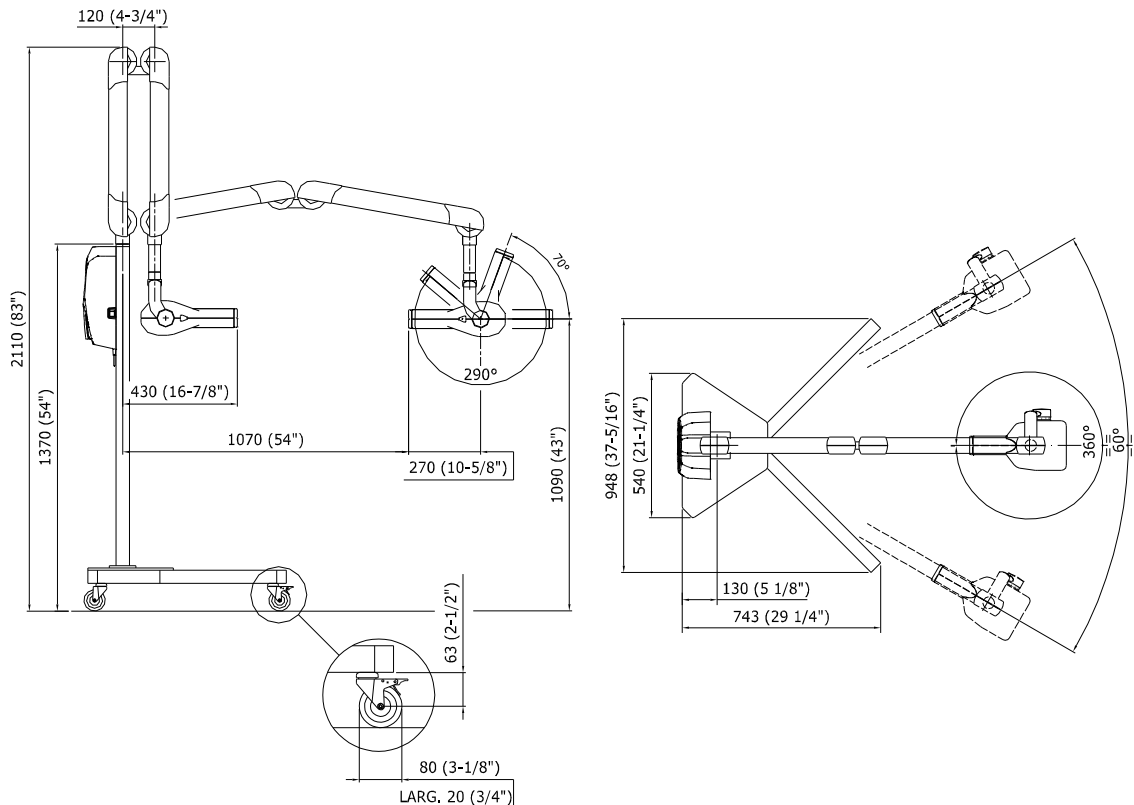

Figure 9: Dimensions of the mobile stand version

7. GENERAL INSTRUCTIONS FOR USE

7.1 Control panel - Description and functions

The Ow-RX control panel is divided into function areas, plus a display to view the operative messages and error signals. The following figure shows a general view of the control panel, while details on each functional area are provided in the following pages.

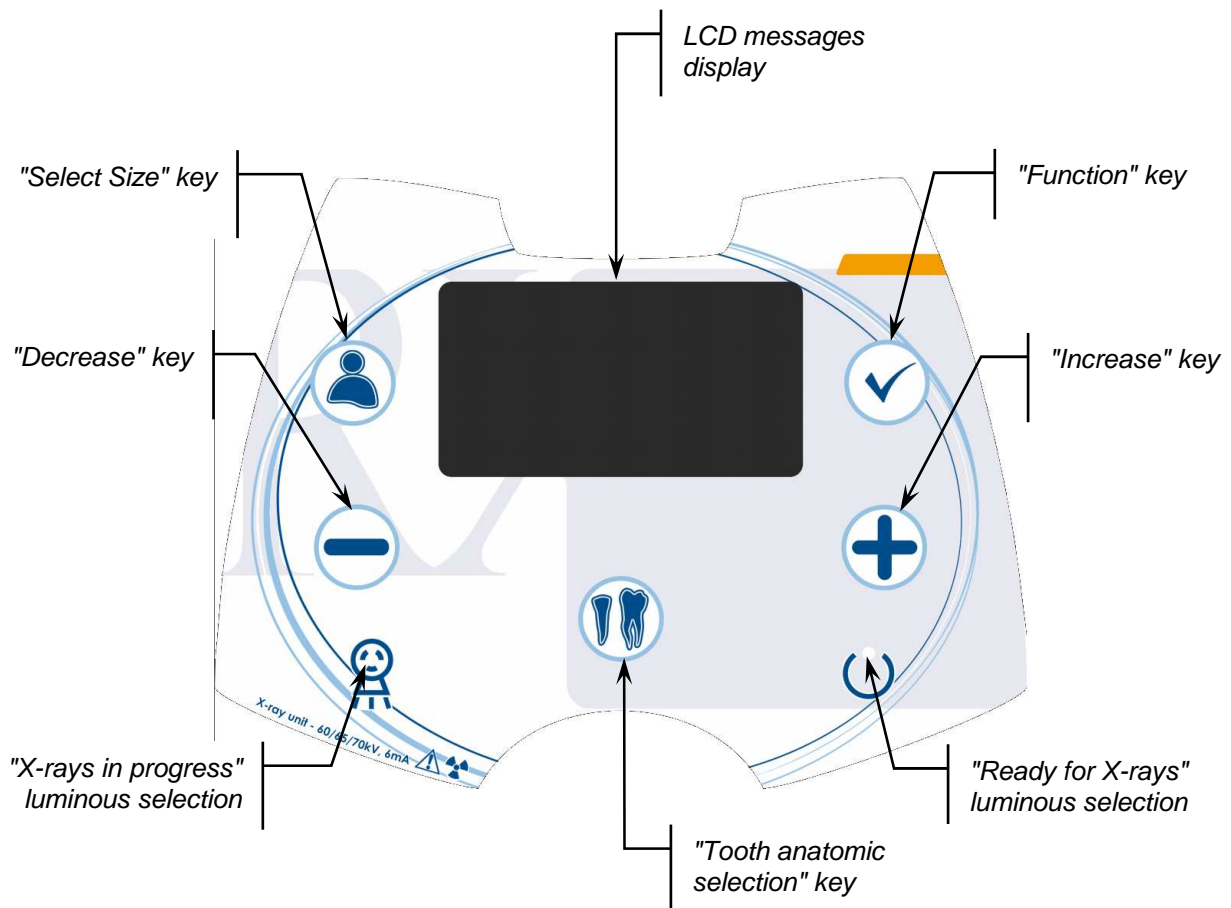

Figure 10: Ow-RX control keypad

The following figure shows the LCD display; details of every function area are shown on the following pages.

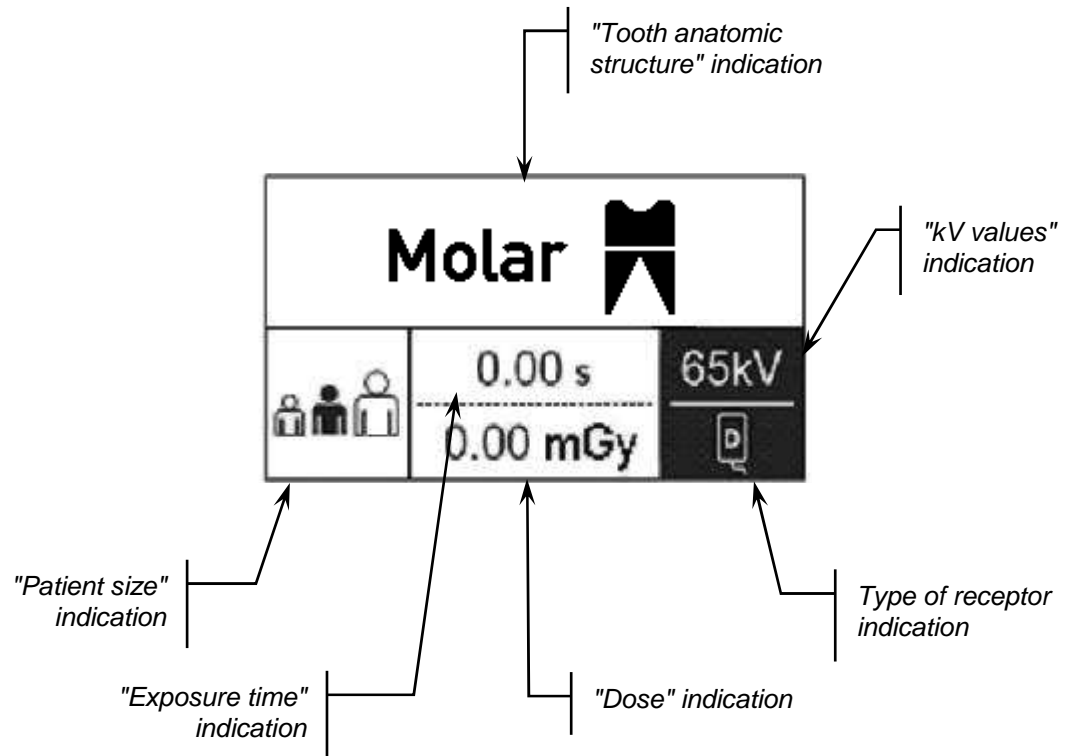









Figure 11: LCD display



7.1.1 "Tooth anatomic selection" key

Press the "Tooth anatomic selection"  key to select in rotation

from among the exposure times pre-set for the various teeth. It is possible to select from among seven different anatomic structures and the selection is shown on the display:

Incisor		
Canine		
Premolar		
Molar		<i>(Lower)</i>
Molar		<i>(Upper)</i>
Bite-wing		<i>(Rear)</i>
Bite-wing		<i>(Front)</i>

7.1.2 "Increase/Decrease" key

The "Increase"  or "Decrease"  keys are used to scroll the different selections in the menus or to manually change the exposure times.

7.1.3 "Select Size" key

Press the "Select size"  key to select in rotation from among the the different patient sizes: small, medium and large.

Also in this case the exposure times will change. An acoustic signal is emitted each time a key is pressed and the selected size will be displayed.

7.1.4 "Function" key (selection of receptor, cone presence and kV value)

Using the "Function"  key it is possible to select:

- an image receptor
- the presence of the long cone (SID 30 cm)
- the value of kV applied to the tube.

1. Press the "Function" key: the receptor icon will start to flash.
2. Use the "Increase" and "Decrease" keys to select the type of receptor, from among:

- Film



- Phosphor



- Digital



3. Confirm the selection by pressing the "Function" key; the icon indicating the presence of the long cone will start to flash (SID 30 cm)



4. Use the "Increase" and "Decrease" keys to select the presence () or absence () of the cone.

5. Confirm the selection by pressing the "Function" key.



NOTE:

If the cone is not present, the relative icon will not appear on the display.

6. The value of kV applied to the tube will start to flash.
7. Use the "Increase" and "Decrease" keys to select the required value (60 kV / 65 kV / 70 kV).

8. Confirm the selection by pressing the "Function" key.



NOTE:

As the setting menu is cyclic, it will return to point 1 (receptor type selection).

9. To exit the setting menu, hold down the "Function" key for approx. 2 s. The system will return to the ready for X-ray state.

8. SYSTEM USE

8.1 Switching ON and OFF the device

Press the power switch located on the right side of the timer cover. This will start the "CHECK" function, which is indicated by an acoustic signal and the turning on of the LEDs and the display.

When the "CHECK" function is complete, the machine will position itself by default in the configuration corresponding to the last selection made.

The unit is now ready for X-rays.



NOTE:

- The ready for X-rays condition is signalled by the switching on of the relative green LED.
- The ready for X-rays condition remains for a set period of time (variable during the installation phase: default 2 minutes), after this period of time has passed, this status will be disabled and pressing the exposure button will not emit rays. The brightness of the display will also be reduced.
- **To return to the ready for X-rays status, the device must be "woken up" by pressing any key (except for the X-ray button).**

Similarly, switching off occurs when the system is switched off by pressing the power switch located on the right side of the timer cover. The LEDs and the display will turn off.

8.2 Programmed/Manual exposure

The operator can select between working with a programmed (anatomic) selection, that is with values set by the manufacturer based on the size and type of tooth, or perform an examination in manual mode, where it is possible to change the set times.

With the programmed (anatomic) selection, it is possible to select the type of receptor used (different types of film, phosphor and digital sensors), the size of the patient and the kV value.

8.2.1 Performing a programmed exposure

If the previous examination was carried out in manual exposure mode, press one of the size selection or anatomic selection keys to switch to programmed exposure mode. In programmed mode it is possible to change the size, type of tooth and kV value.

Each time the "Size selection" key is pressed  , indicated acoustically, the Large patient / Normal patient / Small patient selection changes.

To change the selection of the type of tooth, use the "Tooth anatomic selection" key  .

Each time this key is pressed the selection of the type of tooth changes in rotation. This is signalled acoustically and shown on the display.

Based on the type of film that is selected, the pre-set times are provided in Table 1.

Size	Film (F)		
	Small	Normal	Large
Incisor	0.07	0.10	0.13
Canine	0.07	0.10	0.13
Premolar	0.09	0.13	0.17
Lower molar	0.10	0.15	0.20
Upper molar	0.13	0.19	0.26
Front bite-wing	0.07	0.10	0.13
Rear bite-wing	0.13	0.19	0.26

Table 1



NOTES:

These values are related to film type F. The Ow-RX system can be programmed to use film with different sensitivity levels; the programmed times vary depending on the film's multiplicative factor. It is possible to request this setting from the technician during installation.

If digital radiography is selected, the exposure times are indicated in Table 2.

Size	Digital sensor		
	Small	Normal	Large
Incisor	0.04	0.08	0.10
Canine	0.04	0.08	0.10
Premolar	0.05	0.09	0.11
Lower molar	0.07	0.11	0.14
Upper molar	0.08	0.14	0.19
Front bite-wing	0.04	0.08	0.10
Rear bite-wing	0.08	0.14	0.19

Table 2

The times for permanent phosphor sensors are provided in Table 3.

Size	Permanent phosphors		
	Small	Normal	Large
Incisor	0.07	0.10	0.14
Canine	0.07	0.10	0.14
Premolar	0.08	0.11	0.14
Lower molar	0.09	0.14	0.17
Upper molar	0.09	0.16	0.20
Front bite-wing	0.07	0.10	0.14
Rear bite-wing	0.09	0.16	0.20

Table 3



NOTE:

The times indicated in the tables are relative to the selection 65kV. The times for the 60kV selection are obtained by multiplying the values in the 65kV table by 1.45; they are multiplied by 0.7 for the 70kV selection.





WARNING:

The times indicated in the tables are those set by the manufacturer. It is appropriate that the user adapts the pre-set exposure times according to local regulatory requirements (if any) and the type of receptor used as described in paragraph 8.3. A service technician is required to reset the default times.

8.2.2 Performing a manual exposure

Ow-RX makes it possible to work not only using the programmed mode described above, but also using the manual function.

To access the manual function, press one of the two keys

“Increase”  or “Decrease”  : the size icon will flash.

The display will show the last time value selected in automatic mode; to change it, simply use the “Decrease” or “Increase” keys until reaching the desired value.

The single variation of the time is signalled by an acoustic message; it is also possible to quickly change the exposure time (4 units per second) by holding down one of the “Increase” or “Decrease” keys for more than 2 seconds.





NOTE:

There are 36 times that can be selected manually and range from a minimum of 0.01 s up to a maximum of 2.00 s according to the following table:

**0.01; 0.02; 0.03; 0.04; 0.05; 0.06; 0.07; 0.08; 0.09; 0.10; 0.11; 0.12;
0.14; 0.16; 0.18; 0.20; 0.22; 0.25; 0.28; 0.32; 0.36; 0.40; 0.45; 0.50;
0.56; 0.63; 0.71; 0.80; 0.90; 1.00; 1.10; 1.25; 1.40; 1.60; 1.80; 2.00**



Table 4: Manual exposure times

To return to the automatic time selection, press one of the “Size

selection”  or “Tooth automatic selection”  keys.

8.3 Storing customised times

Ow-RX makes it possible to customise the programmed exposure times in order to adapt them to the user's actual conditions of use. Proceed as follows to store the customised times:

1. Use the "Increase"  and "Decrease"  keys to select the required value.
2. Hold down the "Function"  key until an acoustic signal is emitted: a screen with the request to confirm or cancel the change will appear.
3. Press the "Increase" key to confirm or the "Decrease" key to cancel the change.

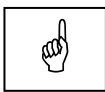

NOTE:

The stored time is related to the size, the tooth, the type of receptor and the kV value shown on the display at that moment.
If the long cone is selected, some time values may be approximate.

8.4 Preparing the tube-head

1. Position the tube-head with an angle suitable for the exposure and positioning required (see Figure 12, Figure 13, Figure 14, Figure 15).
2. Introduce the image receptor in the patient's mouth according to the selected technique (bisector or parallel). In this regard, see paragraph 8.5.
3. Move the tube-head cone towards the patient and direct it exactly towards the tooth to be X-rayed, referring to the following figures.



NOTE:

If you want to use the rectangular collimator, apply it to the end of the tube-head cone, positioning it as needed.



NOTE:

If you want to use the 30 cm extension cone, apply it to the end of the tube-head's 20 cm cone.



WARNING:

If the 30 cm extension cone is applied, the pre-set exposure times will be automatically doubled in order to obtain the same radiographic result.

MANDIBLE

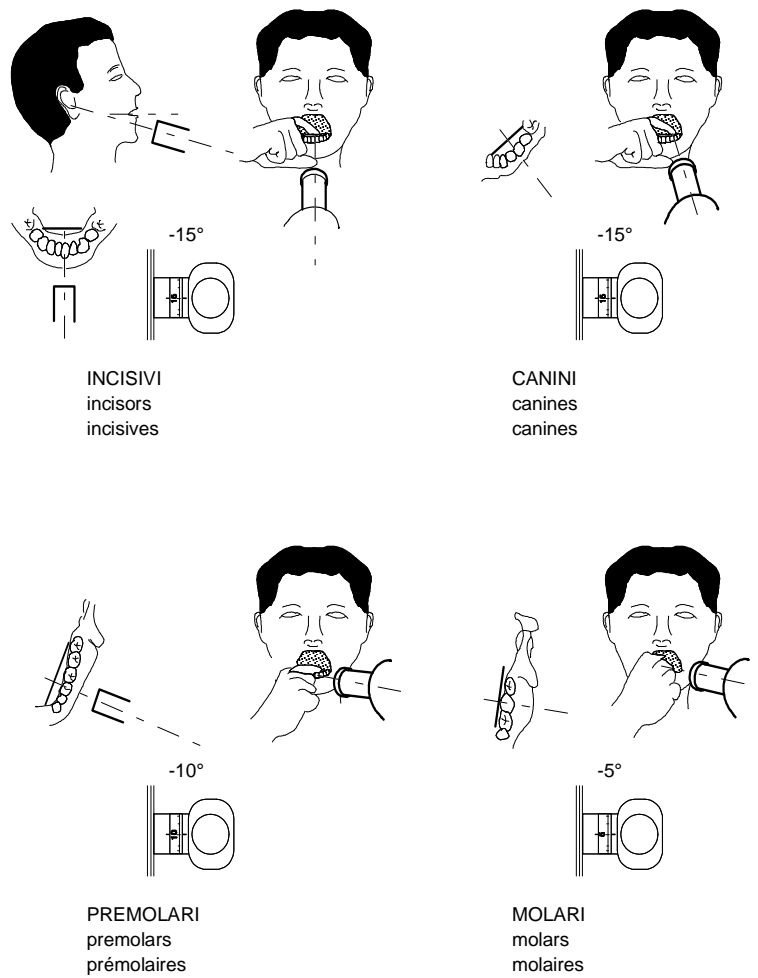

Figure 12

MAXILLA

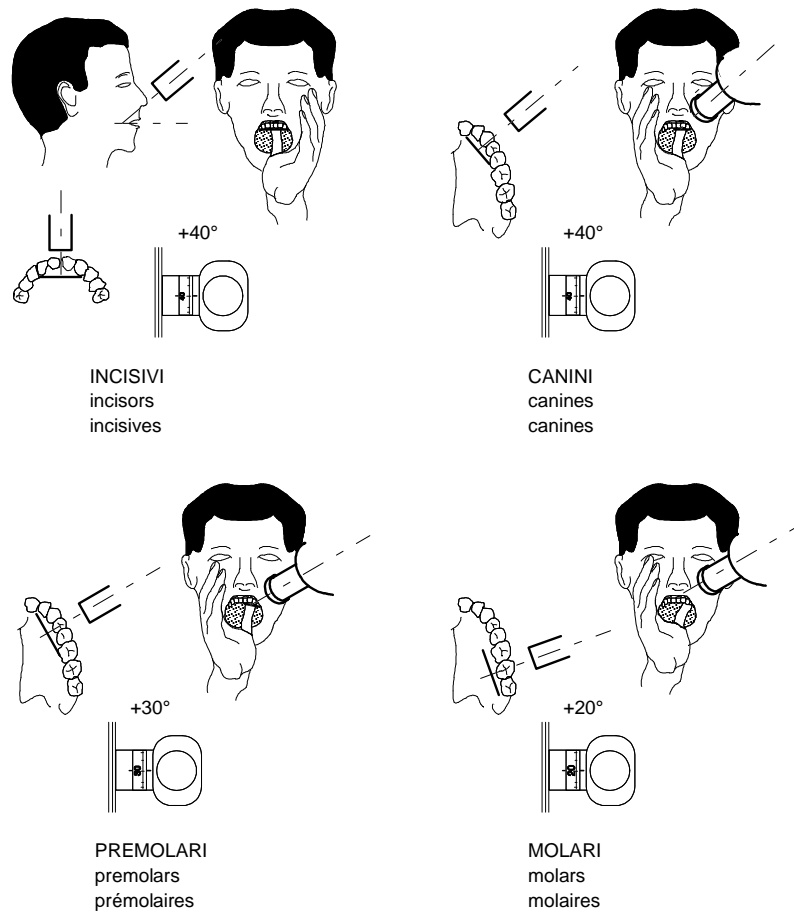

Figure 13

OCCLUSAL

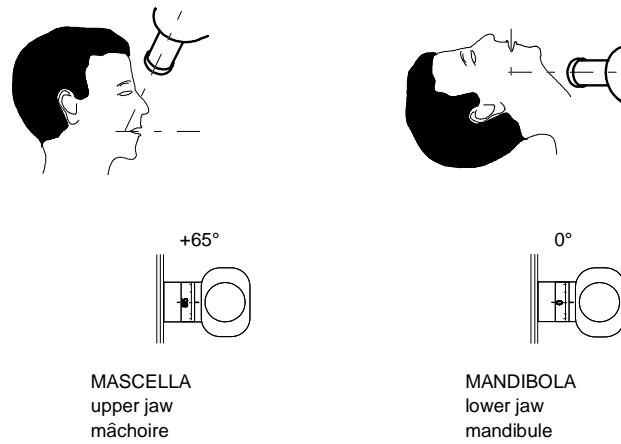

Figure 14

BITE WING

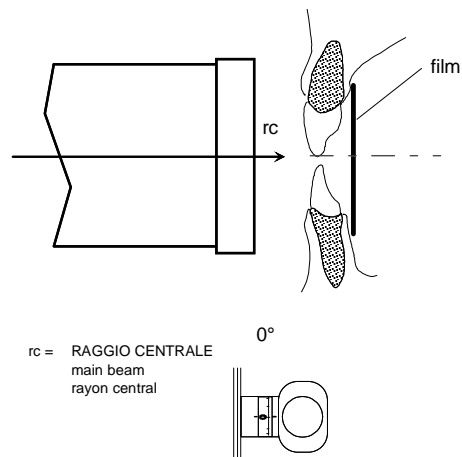

Figure 15

8.5 Exposure techniques

This paragraph describes the various techniques used in general for intra-oral exposure.

8.5.1 Bisector technique

Incidence of the X-ray beam – vertical angle

In order to obtain a real image of the tooth, the ray must be perpendicular to the bisector of the angle formed by the longitudinal axis of the tooth and by the film.

After positioning the X-ray beam and the patient's head based on these criteria, an average vertical incidence can be applied for each area. The incidence angle of the X-ray beam can be correctly measured using the graduated scale located on the tube-head.

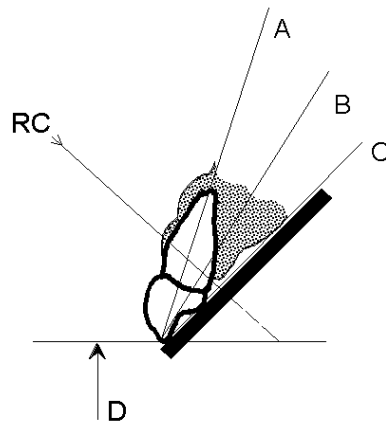

Figure 16

Legend Figure 16:

A – Longitudinal axis of the tooth

B – Bisector

C – Film surface

D – Occlusal surface

RC – X-ray beam

Incidence of the X-ray beam – horizontal direction

The X-ray beam must be adjusted horizontally, in particular in the orthoradial direction relative to the interproximal spaces (see Figure 17), to prevent an overlapping of structures (see Figure 18).

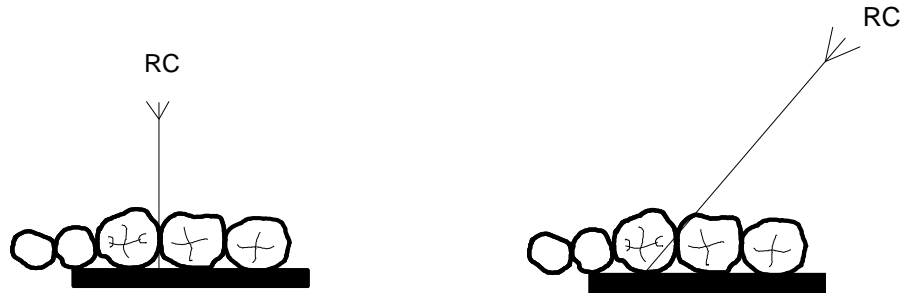

Figure 17
(Correct position)

Figure 18
(Incorrect position)

Legend Figure 17 and Figure 18

RC – X-ray beam

8.5.2 Parallel technique

With this technique, the surface of the film is positioned parallel to the tooth's axis. Due to anatomic factors, the film is kept far from the lingual surface of the tooth in general, with the exception of molars.

When the film is introduced into the patient's mouth, it is fixed on a support to prevent distortion. The patient holds the support with his teeth.

Various types of supports are available on the market that can be adapted to different types of teeth. This technique makes it easier to obtain more accurate and repeatable X-rays than with the bisector technique (see Figure 19 and Figure 20).

HORIZONTAL SECTION

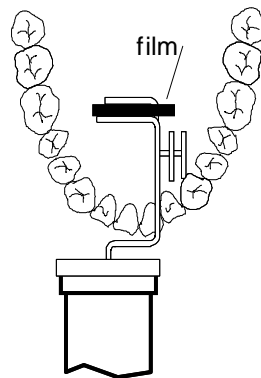

Figure 19

VERTICAL SECTION

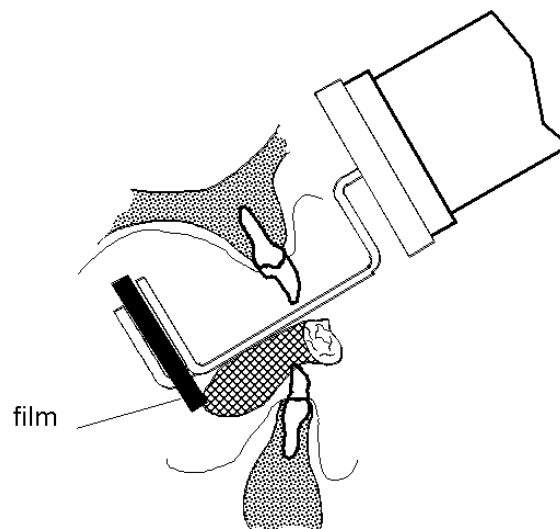

Figure 20

8.6 Exposure with the supplied X-ray button

1. Using the main keypad, select the exposure time as described in paragraph 8.4, based on the selected mode.
2. Move away the distance permitted by the X-ray button cable in the opposite direction of the X-ray beam.
3. Press the X-ray emission button and hold it down during the exposure.
4. A yellow light and an acoustic signal indicate the start of exposure.



WARNING:

- The X-ray emission button is a “dead-man” control; therefore it must be held down during the entire exposure.
- If the button is released before the end of the exposure, the emission is automatically stopped; this situation is shown on the display by the message “**E13**”, if the button was released during pre-heating and “**E12**” if the button was released during the emission of X-rays.

This message will remain displayed until the “Increase”  key is pressed.

-
5. At the end of exposure, the system starts the tube-head cooling cycle (30 times the exposure time). The time until the end of the pause is shown on the display.



NOTE:

For all exposure times shorter than 0.20s, the cooling pause is constant and equal to 6s.

-
6. If the X-ray button was already pressed at the end of the cooling pause, the exposure will be inhibited and the error “**E11**” will be displayed.



NOTE:

All the system statuses are shown on the display during the exposure: preheating, X-ray emission and the cooling pause.

8.7 Exposure with the wireless X-ray button (optional)

It is possible to make an exposure using the wireless X-ray button. Proceed as follows:

1. Press and release the wireless X-ray button. The green LED will turn on, indicating that the communication with the timer was successful.
2. Move away the desired distance (no greater than 5m), in the opposite direction of the X-ray beam.
3. Press the X-ray emission button and hold it down during the entire exposure.

The procedure continues as described in paragraph 8.6, points 4, 5 and 6.

4. At the end of exposure, the green LED on wireless button flashes quickly two times.

In the following table are described the different wireless X-ray button green LED status.

Description	Flashing frequency	Duration	Action
Ready to exposure	Fixed	Fixed	--
Wireless button communication failure	High	2 seconds	Check that the device is not switched off or in sleeping/cooling mode. If the device is active, perform matching procedure (see paragraph 8.7.2)
Matching procedure failed	High	10 flashes	Repeat matching procedure (see paragraph 8.7.2)
Matching procedure OK	Low	10 flashes	--
Low battery	Very high	2 sequences of 5 flashes	Replace battery (see paragraph 8.7.1)
Very low battery	Very high	4 sequences of 5 flashes	Replace battery (see paragraph 8.7.1)
Wireless button faulty	LED off	--	Contact the technical support

8.7.1 Indication of the battery charge status and replacement.

The wireless X-ray button diagnoses the status of battery.
If the battery level is lower than 2.7V, the remote control informs the user with 2 sequences of 5 very high flashes.

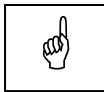

NOTE:

In this situation, a few exposures can be made, but the batteries should be replaced as soon as possible.

Proceed as follows to replace the batteries:

- unscrew the two screws located on the back of the button
- open the two half-shells, keeping the green button facing upwards and paying attention to the electronics located inside
- replace the batteries respecting the indicated polarities
- reclose the two half-shells and tighten the screws.



If the charge level is lower than 2.4V, the LED on the remote control will perform 4 sequences of 5 very high flashes and exposures cannot be made.

8.7.2 Matching procedure between the remote control and timer

The wireless X-ray button will only work with the timer with which it was combined.

If for some reason the two devices must be combined again, proceed as described in the Service Manual.

8.8 Display of the number of exposures made

With the ready for X-ray status, the user is able to view the number of exposures made by pressing the “Increase”  and “Tooth automatic selection”  keys at the same time.

The number will be shown on the display for approx. 3s.

9. ERROR MESSAGES ON THE DISPLAY

Ow-RX is fully controlled by a microprocessor which controls the programming of the emission parameters and signals the various conditions of the machine, the possible abnormalities and errors via displayed messages.

The following tables show the various messages that can appear on the display, their meaning and their cause.

The error messages are separated into three different categories, classified based on the severity of the abnormality discovered and their possible effect on the safety of the operators and/or the system.

9.1 Fatal errors upon power-up and in the ready, idle and cooling statuses

These signals do NOT permit an examination to be performed.

It is possible to try to turn the equipment off and on, but if the signal is repeated, technical assistance must be contacted.

Displayed message	Type of ABNORMALITY	ACOUSTIC signal
E01	X-ray button pressed at power-up	None
E02	A key pressed at power-up (other than the X-ray button)	None
E03	Multiple keys pressed at power-up	None
E05	Unwanted X-ray emission	Present as long as RX ON is active



WARNING:

If E01 is displayed, release the X-ray button; if this has not been pressed, this indicates a fault, therefore call the support service.

9.2 Fatal errors during X-ray emission

Any abnormalities during the X-ray beam always stop the emission. The presence or absence of the acoustic signal depends on the moment in which the problem occurred and on the success of the procedure for stopping the rays.

These errors cannot always be removed without turning off the device and in most cases indicate situations of system faults or deterioration that require the intervention of technical assistance.

Displayed message	Type of ABNORMALITY	ACOUSTIC signal
E04	No emission	None
E06	Activation of the back-up timer	None
E07	Protection intervention	None
E50	Spurious CPU reset	None



WARNING:

If an error message appears and the buzzer sounds, always turn off the system. In any case, the intervention of the back up timer always stops X-ray emission.

9.3 NON fatal errors

Situations that do not directly involve the safety of the operator, the patient or the system are considered as resettable anomalies. The error condition prevents additional exposures until it is reset

by pressing the "Increase"  key.

Displayed message	Type of ABNORMALITY	ACOUSTIC signal
CH0	Memory checksum error (EEPROM)	None
E11	X-ray button active after the cooling phase	None
E12	Release of X-ray button during emission	None
E13	Release of button during the pre-heating phase	None



WARNING:

If CH0 is displayed, the EEPROM will be reinitialized to the default parameters. In case of errors at switch ON or setup messages different than the original ones, call the technical service to restore customizations.

If E12 is displayed, the X-ray button was released with the emission in progress, therefore the film must be replaced or the image receptor must be restarted to obtain the diagnostic results.

If E11 is displayed, release the X-ray button; if this has not been pressed, this indicates a fault, therefore call the support service.

10. CONTROL AND CORRECTION OF ANY ERRORS IN THE DENTAL X-RAYS

10.1 Typical defects of intra-oral X-rays

- **X-rays too light**

Possible causes:

- Insufficient X-ray exposure (short time)
- Insufficient development time
- Film processor damaged
- Film processor temperature lower than the recommended value
- Incorrect dilution of the developing liquids.

- **X-rays too dark**

Possible causes:

- Excessive X-ray exposure
- Excessive development time
- Film processor temperature higher than the recommended value
- Incorrect dilution of the developing liquids.

- **X-rays out of focus (impossible to see the details)**

Possible causes:

- The patient moved
- The tube-head moved.

- **X-rays with herringbone shaped marks**

Some intra-oral films have a thin layer of lead in the package that engraves a few herringbone shaped marks in the lower part. These films can only be exposed to radiation on one side. If the film is exposed from the wrong side, the layer of lead will absorb a large quantity of radiation during exposure. The result will be a lighter X-ray and the film will show herringbone shaped marks.

- **X-rays partially exposed**

Possible causes:

- Rays directed far from the median section of the film
- Level of the developing liquids is too low, resulting in the partial development of the film
- Two or more films placed next to each other in the film processor.

- **Obscured X-rays**

Possible causes:

- Film stored for too long (check expiration date)
- Accidental exposure of the film to rays
- Accidental exposure of the film to other sources of natural or artificial light.

- **Dark line on the X-rays**

This line appears when the film is folded excessively.

- **X-rays with traces of electrostatic electricity**

When the film is compressed excessively and the air is dry, electrostatic electricity may be released, which is discharged in the compression points, on which black branching marks will appear.

- **X-rays with chemical spots**

Scattering the developing fluid or fixer on the film before development and the fixing procedures will create spots on the X-ray; these spots are:

- Dark if caused by the developing liquid
- Light if caused by the fixer.

- **X-rays with loss of emulsion**

If the film is left in a hot water bath for too long (for example, overnight), the emulsion may soften and detach partially from the base of the film. After development, the film will appear scratched.

10.2 Typical defects caused by incorrect positioning

- **X-rays with elongated or shortened images**

The X-ray beam is not perpendicular to the bisector of the angle formed by the longitudinal axis of the tooth and by the film.

- **X-rays with the top of the tooth elongated**

Probably caused by the excessive folding of the film in the patient's mouth.

11. MAINTENANCE

This unit, like all other electrical appliances, must be used correctly and also serviced and controlled at regular intervals. This precaution ensures a safe and efficient performance.

The periodical maintenance consists in checks performed by the operator himself and/or by a qualified Technician.

The operator can control the following items:

Frequency	Type of check	Method
Daily	Functioning of the indicator lights	Visual inspection
Daily	Check that the remote control cable does not show signs of breaking or wear	Visual inspection
Daily	Check that the unit is not damaged externally as to compromise the safety of protection from radiation	Visual inspection
Daily	Check that there are no traces of oil on the tube-head	Visual inspection
Daily	Check the balancing of the scissors arm	Practical inspection
Monthly	Integrity of equipment and labels	Visual inspection



WARNING:

If the operator detects irregularities or failures, he must immediately call the Technical Service.

The Service Engineer, during preventive maintenance, besides the checks listed above, will verify also:

Frequency	Type of check
Annually	Correct adjustment of the rotation friction mechanism of the extension arm and of the scissors arm
Annually	Correct balancing of scissors arm, making proper adjustment when necessary

MAINTENANCE LOGBOOK

Installation: Date Technician

Maintenance: Date Technician

Cause

Maintenance: Date Technician

Cause

Maintenance: Date Technician

Cause

Maintenance: Date Technician

Cause

Maintenance: Date Technician

Cause

Maintenance: Date Technician

Cause

Maintenance: Date Technician

Cause



Cod. 6959902203_Rev.6

CE 0051